

AUFBAUANLEITUNG

# **BALDACHIN**

isle of dogs<sup>®</sup>

D · E · S · I · G · N

WUPPERTAL



## STÜCKLISTE

**A** CONFIRMAT SCHRAUBE  
70MM



**8 stk**

**B** HOLZDÜBEL 8X16



**4 stk**

**C** FILZ Ø40MM

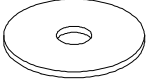

**4 stk**

**D** IMBUSS-SCHLÜSSEL



**1 stk**

## LISTE DER EINZELTEILE

**1** VERTIKALE STÜTZEN VOM HIMMELAUFSATZ

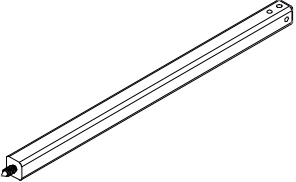

**4 stk**

**2** LÄNGSVERSTREBUNG HIMMELAUFSATZ

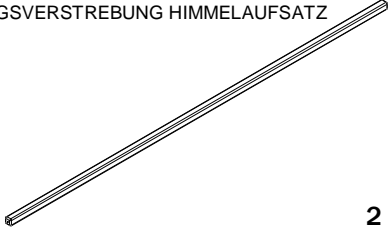

**2 stk**

**3** QUERVERSTREBUNG HIMMELAUFSATZ

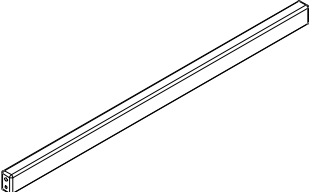

**2 stk**

# SCHRITT 1

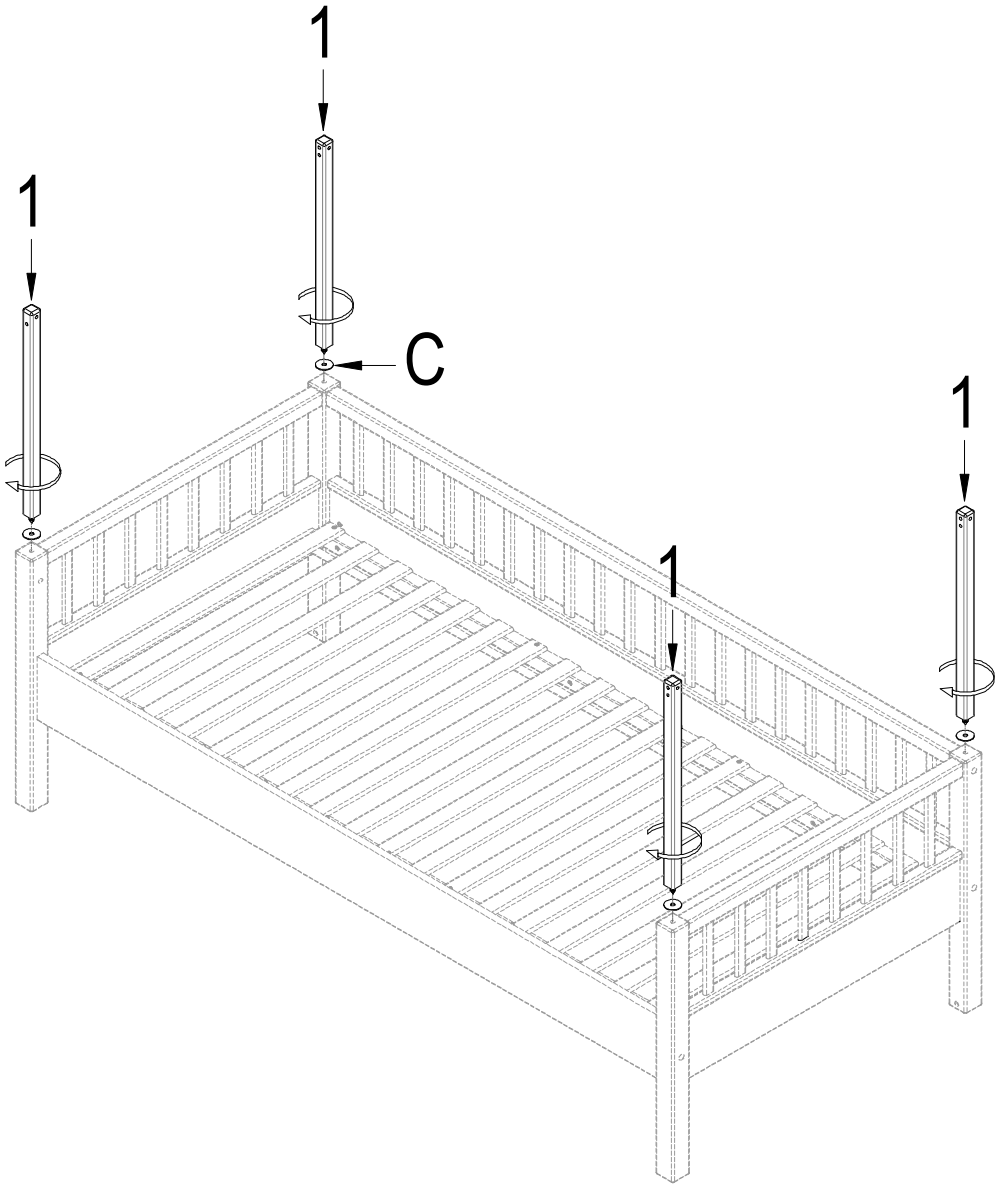

**SCHRITT 2**

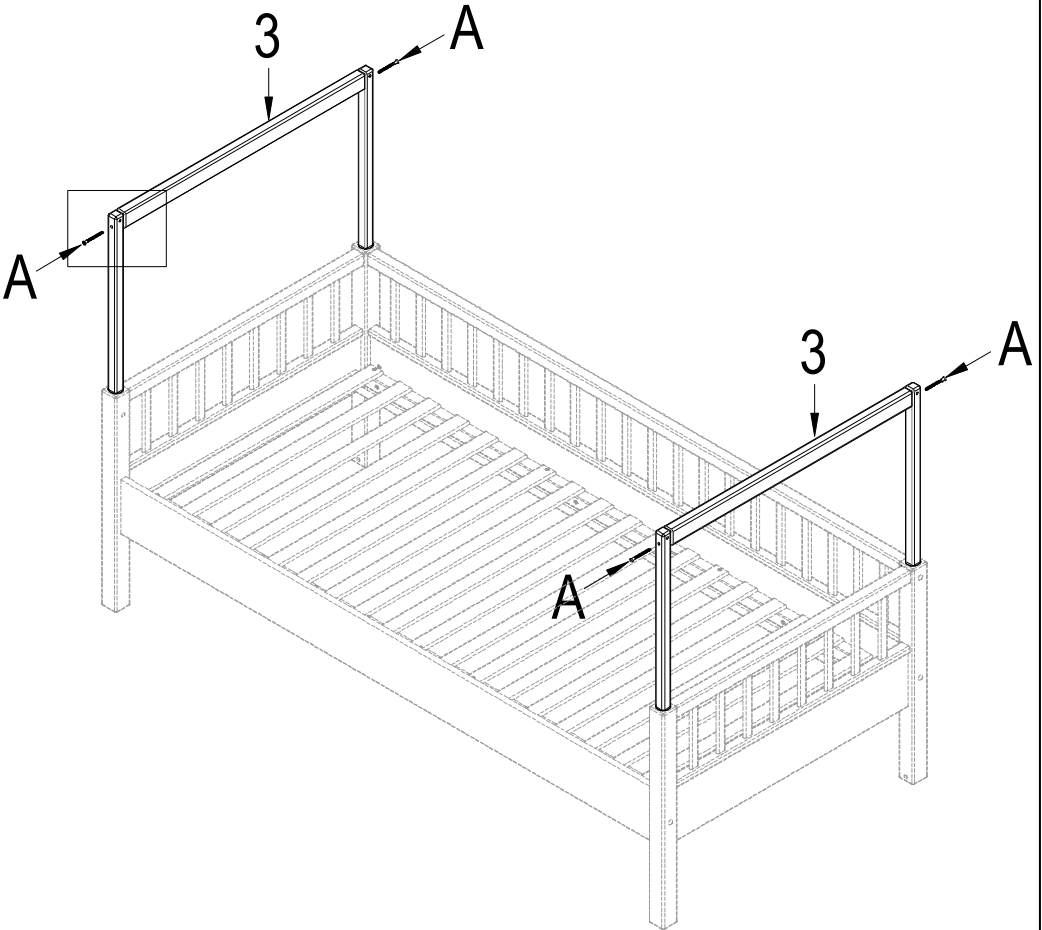
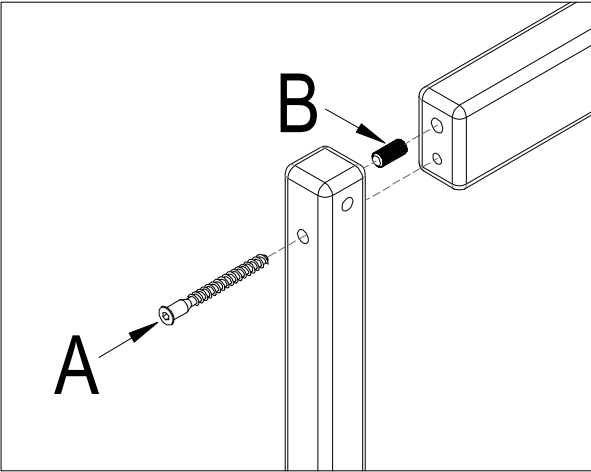

SCHRITT 3

