

AUFBAUANLEITUNG  
ZAUN AUF RÄDERN

isle of dogs<sup>®</sup>

D · E · S · I · G · N

WUPPERTAL



## STÜCKLISTE

**A** CONFIRMAT SCHRAUBE  
70MM  
  
2 stk

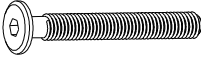
**B** SCHRAUBE M6x50  
  
4 stk

**C** UNTERLEGSSCHEIBE  
  
4 stk

**D** IMBUSS-SCHLÜSSEL  
  
1 stk

## LISTE DER EINZELTEILE

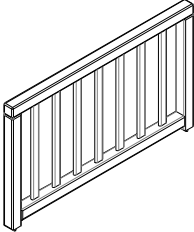
**1** ZAUN  
  
1 stk

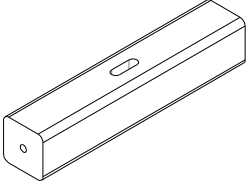
**2** ZWISCHENSTÜCK  
  
2 stk

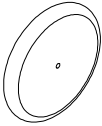
**3** RAD  
  
4 stk

SCHRITT 1

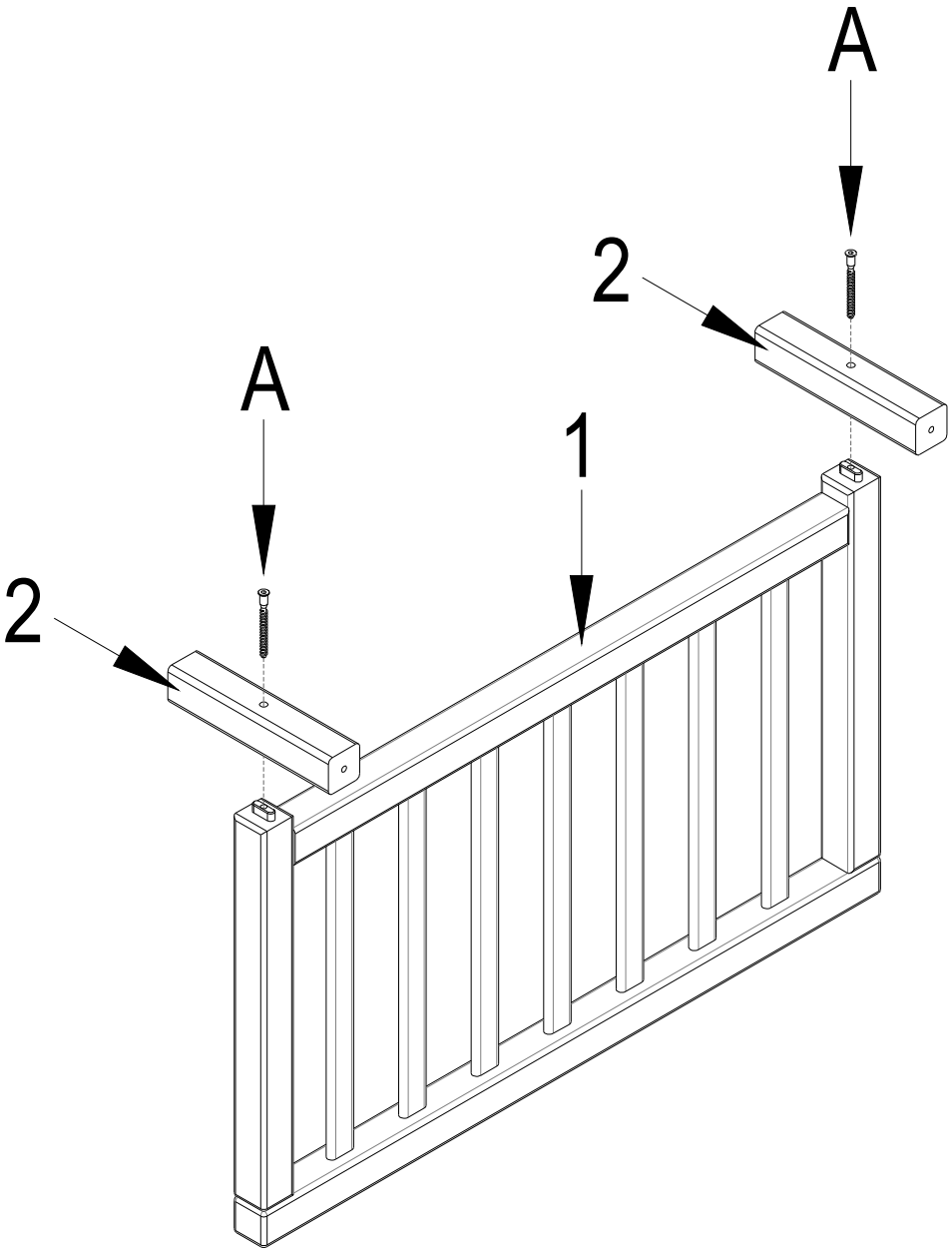

**SCHRITT 2**

