

AUFBAUANLEITUNG

HOHES REGAL

100 X 200 X 38 CM







isle of dogs

D · E · S · I · G · N

WUPPERTAL

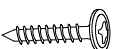
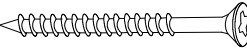

Stückliste

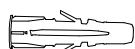
A	Einschraubdübel  28 Stück	B Exzenter-Verbinder 15 x 13  28 Stück	C Schraube 4 x 13  1 Stück
D	Holzdübel 8 x 32  8 Stück	E Schraube für Rückwand 3 x 20  40 Stück	F Schraube 5 x 60  1 Stück
G	H Sicherheitsband (Kippschutz) 125 x 25  1 Stück		Plastikdübel 8 x 50  1 Stück

Liste der Einzelteile

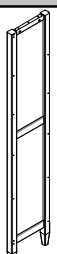
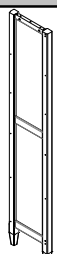
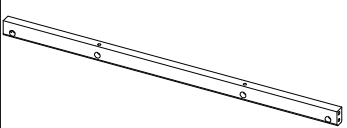
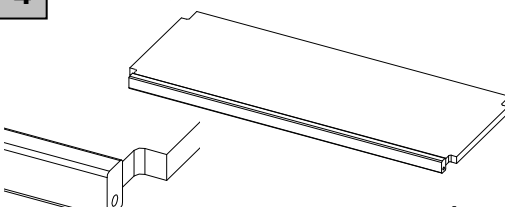
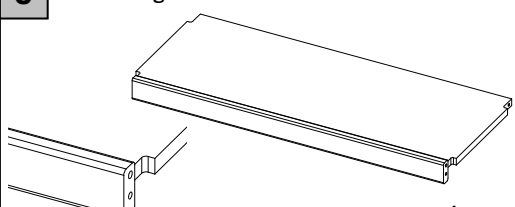
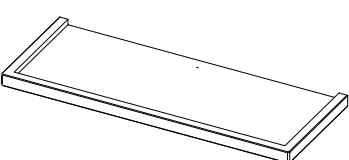
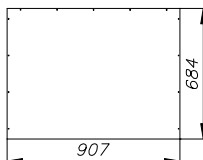
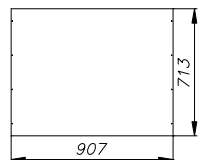
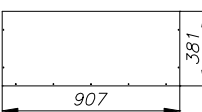
1 linke Regalseite  1 Stück	2 rechte Regalseite  1 Stück	3 vordere obere Leiste  1 Stück	
4 mittlerer Regalboden  4 Stück		5 unterer Regalboden  1 Stück	
6 Deckel  1 Stück	7 oberer Teil Rückwand  907 x 684 1 Stück	8 mittlerer Teil Rückwand  907 x 713 1 Stück	9 unterer Teil Rückwand  907 x 381 1 Stück

Schritt 1

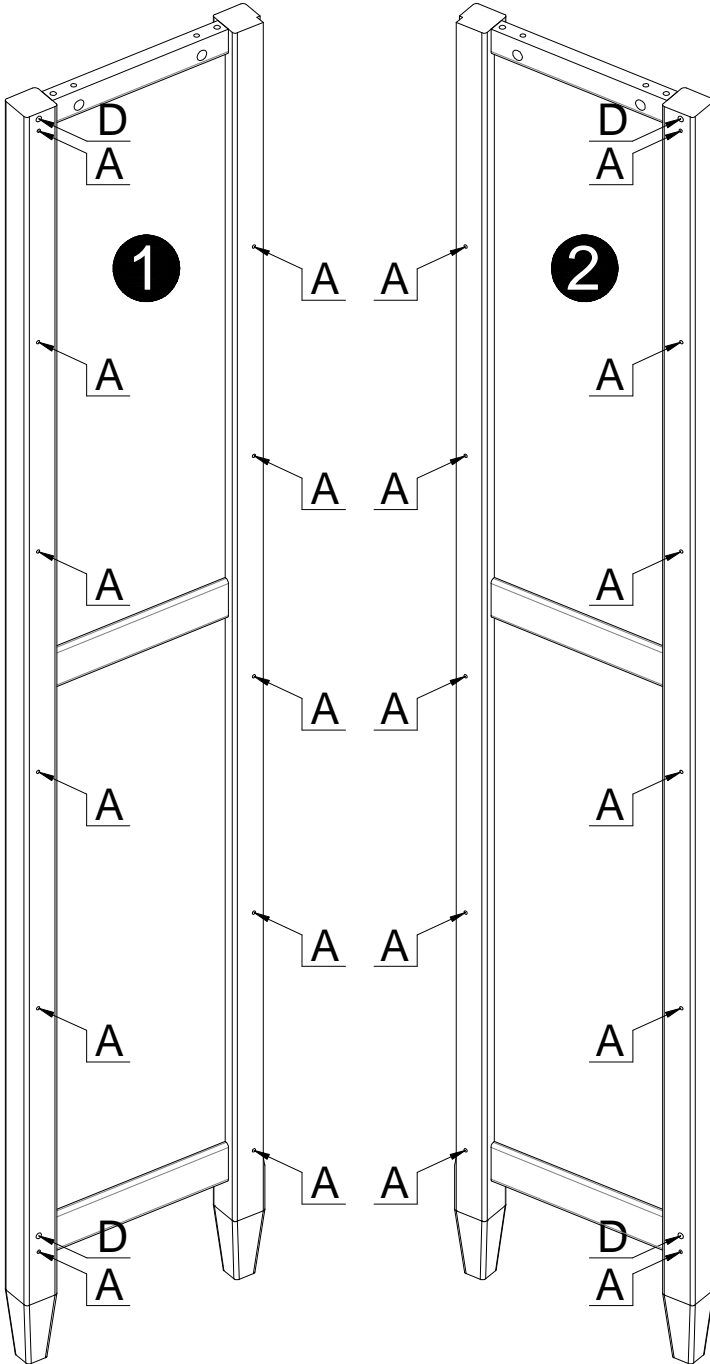

Schritt 2

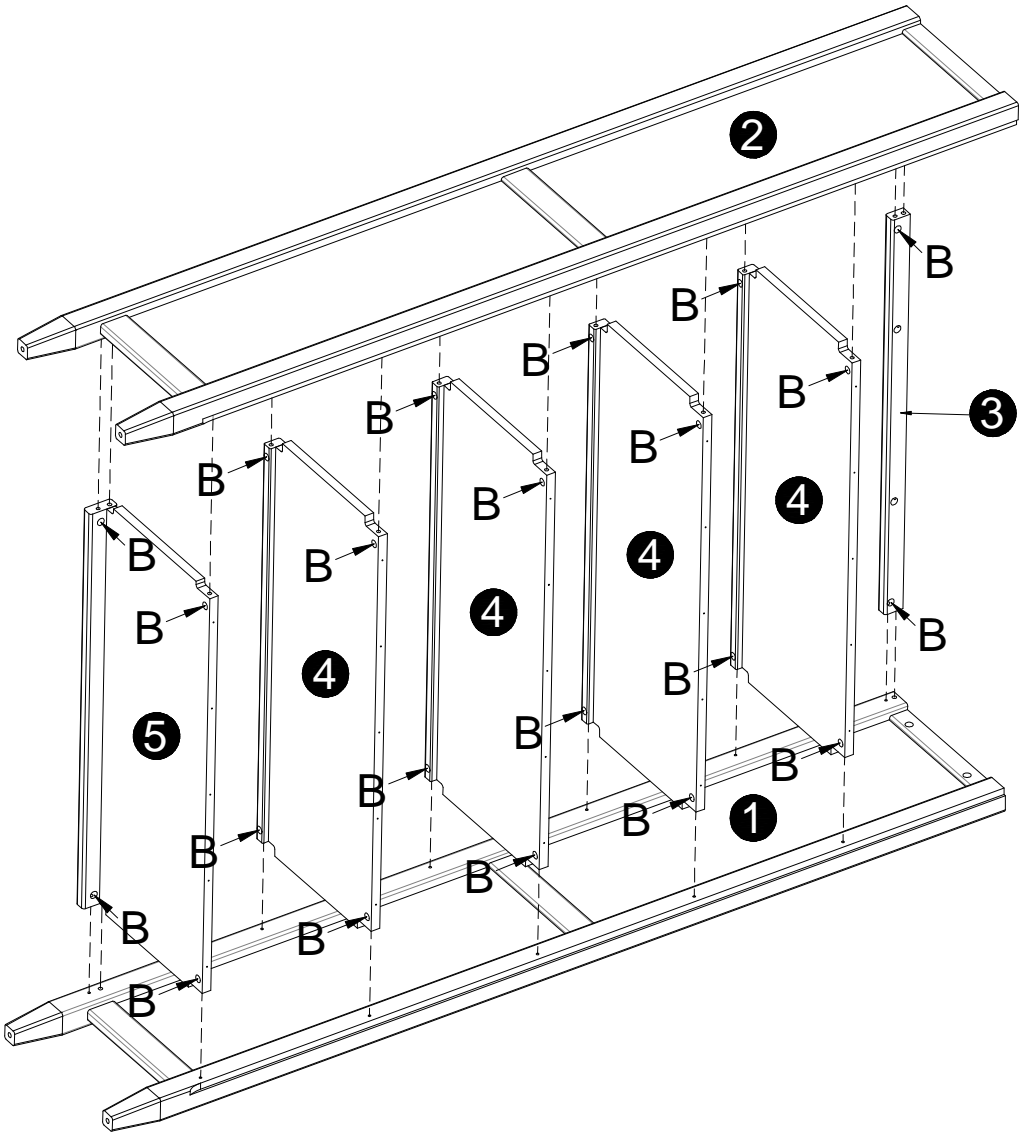

Schritt 3

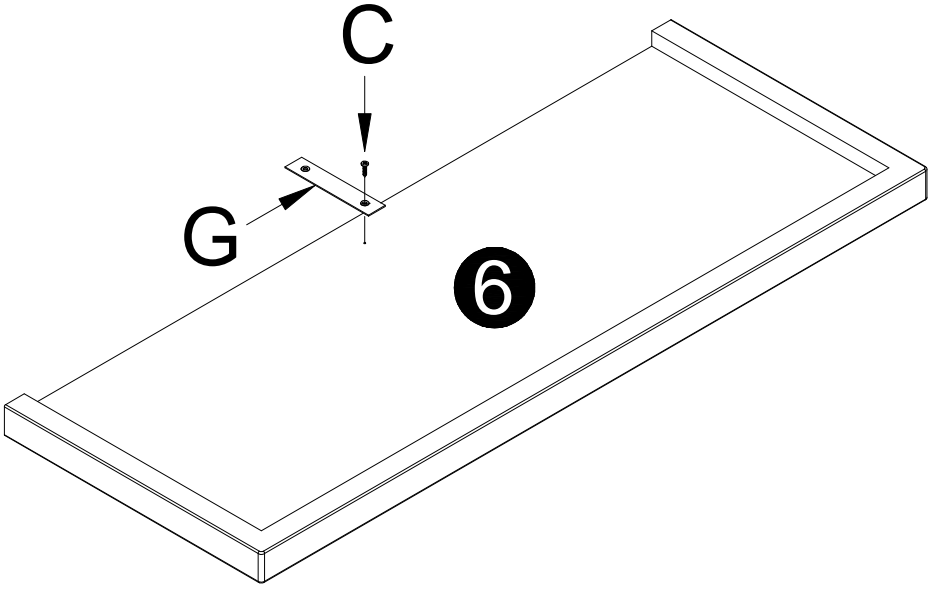

Schritt 4

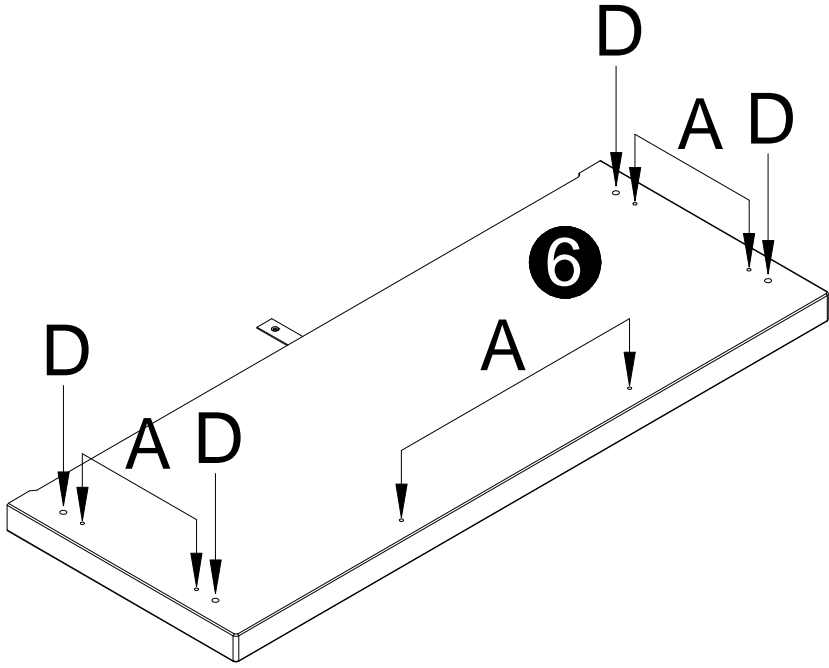

Schritt 5

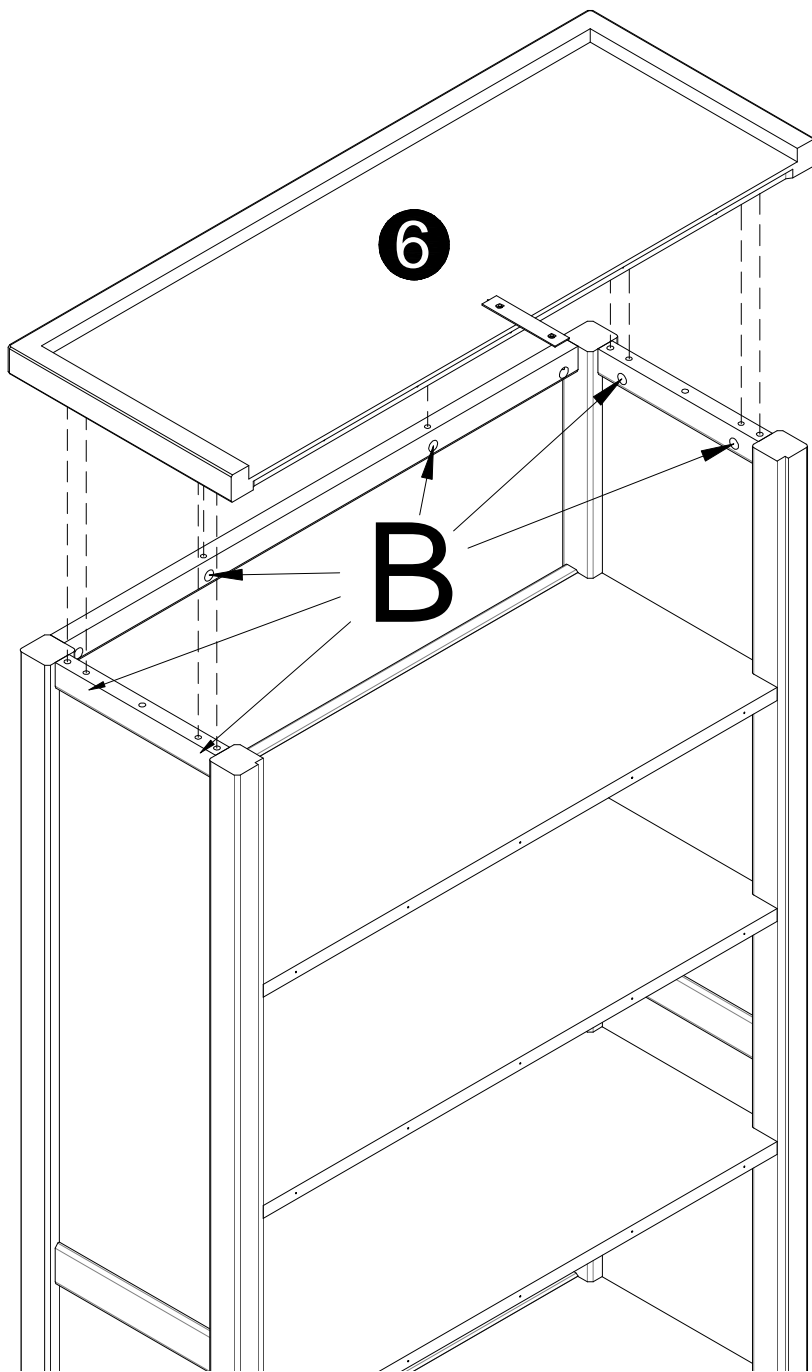

Schritt 6

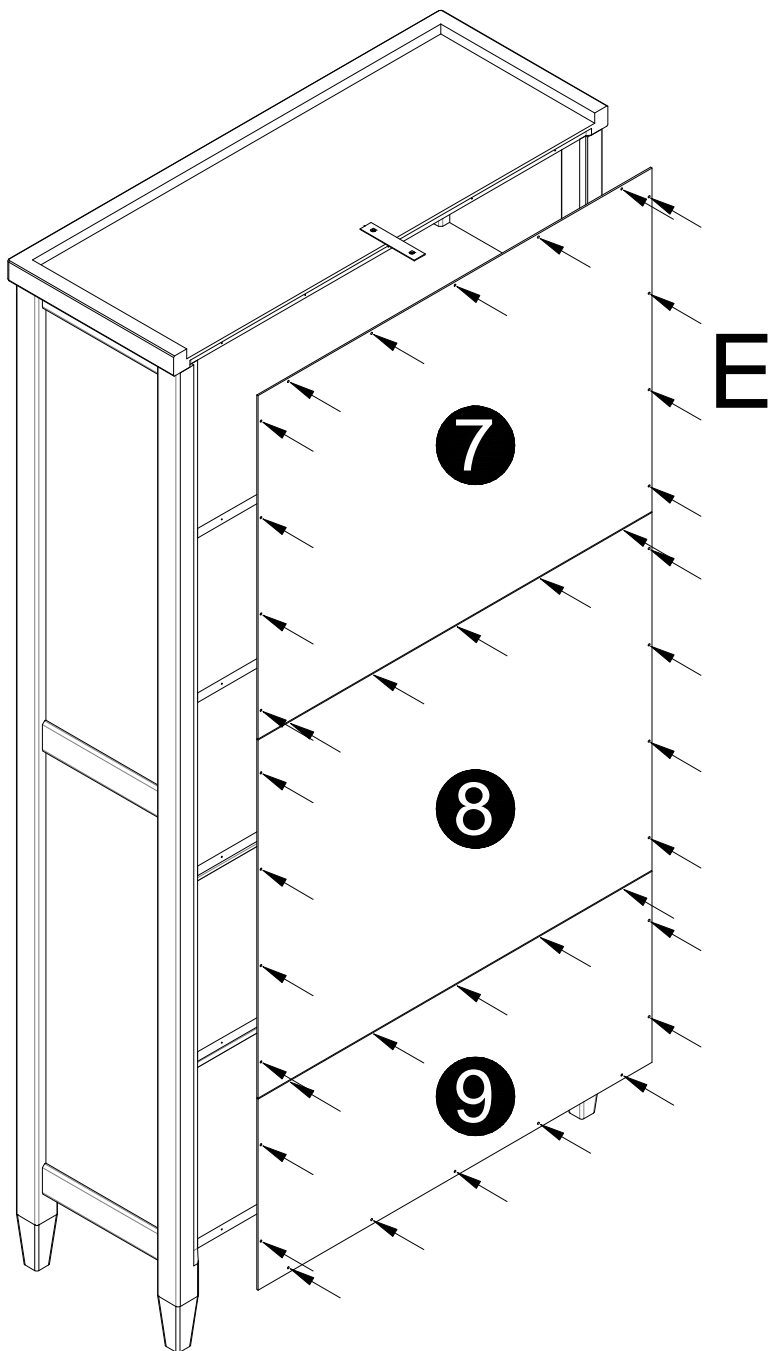

Schritt 7

